

WORK BENCHES



**LONGSPAN
WORK BENCHES**



**4 TIER
LONGSPAN
WORK BENCHES**



**PALLET RACKING
WORK BENCHES**



Undershelf Options

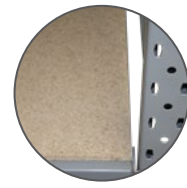
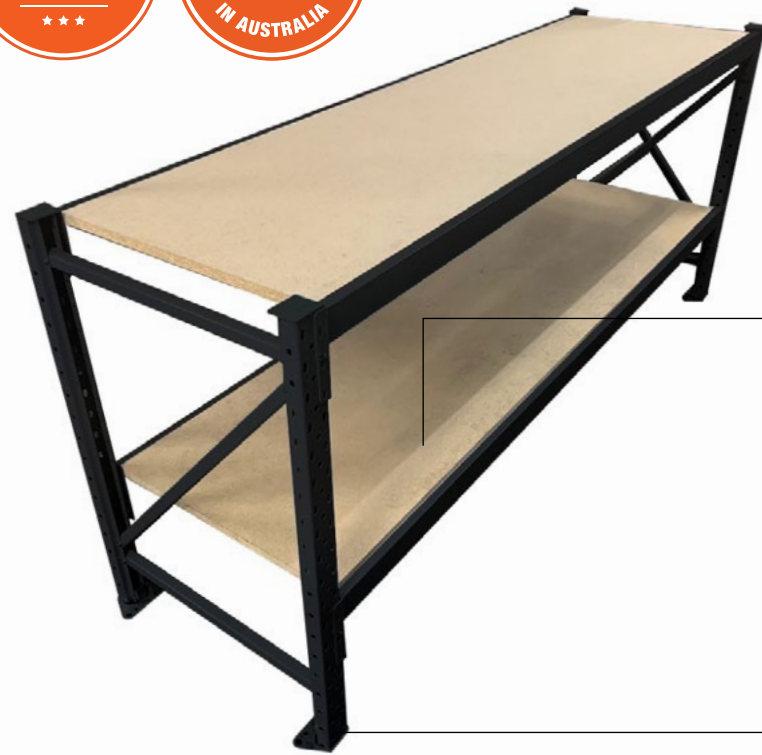

Timber

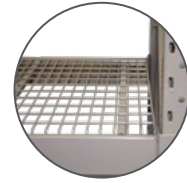

Wire

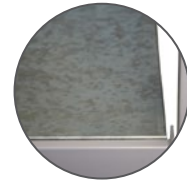

Galvanised

Wheels

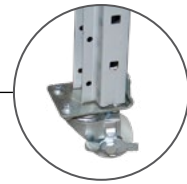

Wheels w/ Brake
Wheels w/o Brake

Longspan Work Bench Standard Finishes

Powder-coated

White

Grey

Black

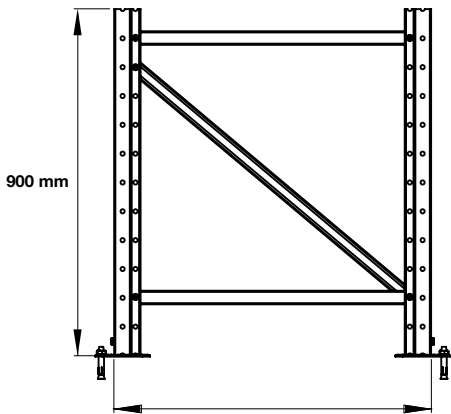

900 mm

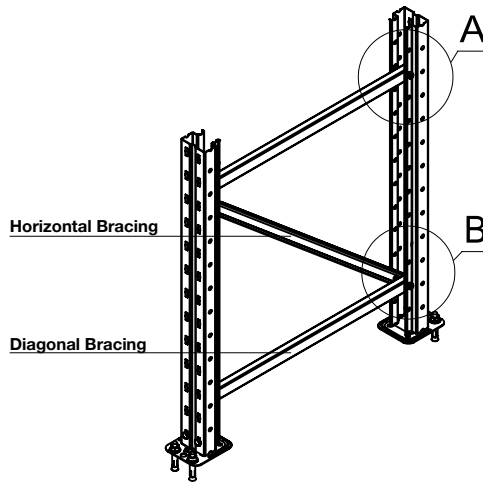

Horizontal Bracing

Diagonal Bracing

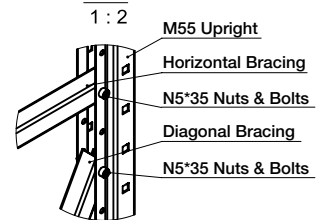

1 : 2

- M55 Upright
- Horizontal Bracing
- N5*35 Nuts & Bolts
- Diagonal Bracing
- N5*35 Nuts & Bolts

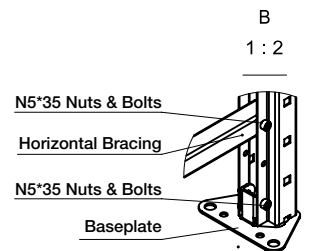

B

1 : 2

- N5*35 Nuts & Bolts
- Horizontal Bracing
- N5*35 Nuts & Bolts
- Baseplate

OPTIONAL WIDTHS 600, 800, 1200 mm

BEAM LENGTH 900, 1200, 1500, 1800, 2000, 2400, 2700, 3000 mm

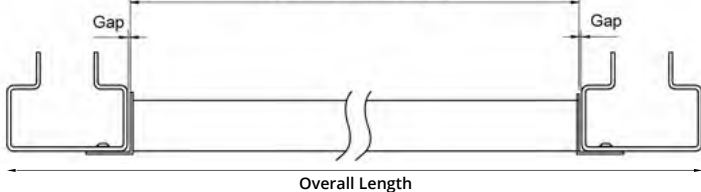

Overall Length

Top View

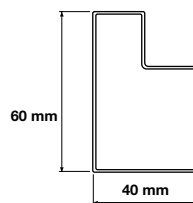

60 mm

40 mm

Step Beam
Cross Section



Step Beam
Side View

LONGSPAN WORK BENCH CONFIGURATION

Standard
Work bench

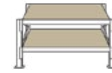

Wire
Undershelf

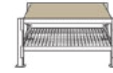

Galvanised
Undershelf

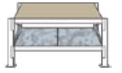

Code	Beam Length	Depth	Overall Length	RRP (Inc GST)	RRP (Inc GST)	RRP (Inc GST)
LSWB9060 (-T,W,G,B)	900 mm	600 mm	1010 mm	\$176.00	N/A	N/A
LSWB9080 (-T,W,G,B)	900 mm	800 mm	1010 mm	\$192.00	N/A	N/A
LSWB90120 (-T,W,G,B)	900 mm	1200 mm	1010 mm	\$256.00	N/A	N/A
LSWB12060 (-T,W,G,B)	1200 mm	600 mm	1310 mm	\$184.00	\$217.00	\$199.00
LSWB12080 (-T,W,G,B)	1200 mm	800 mm	1310 mm	\$210.00	\$243.00	N/A
LSWB120120 (-T,W,G,B)	1200 mm	1200 mm	1310 mm	\$274.00	N/A	N/A
LSWB15060 (-T,W,G,B)	1500 mm	600 mm	1610 mm	\$214.00	\$257.00	\$230.00
LSWB15080 (-T,W,G,B)	1500 mm	800 mm	1610 mm	\$248.00	\$289.00	N/A
LSWB150120 (-T,W,G,B)	1500 mm	1200 mm	1610 mm	\$342.00	N/A	N/A
LSWB18060 (-T,W,G,B)	1800 mm	600 mm	1910 mm	\$228.00	\$276.00	\$249.00
LSWB18080 (-T,W,G,B)	1800 mm	800 mm	1910 mm	\$262.00	\$311.00	N/A
LSWB180120 (-T,W,G,B)	1800 mm	1200 mm	1910 mm	\$356.00	N/A	N/A
LSWB20060 (-T,W,G,B)	2000 mm	600 mm	2110 mm	\$250.00	\$308.00	\$272.00
LSWB20080 (-T,W,G,B)	2000 mm	800 mm	2110 mm	\$290.00	\$347.00	N/A
LSWB200120 (-T,W,G,B)	2000 mm	1200 mm	2110 mm	\$410.00	N/A	N/A
LSWB24060 (-T,W,G,B)	2400 mm	600 mm	2510 mm	\$272.00	\$337.00	\$301.00
LSWB24080 (-T,W,G,B)	2400 mm	800 mm	2510 mm	\$312.00	\$380.00	N/A
LSWB240120 (-T,W,G,B)	2400 mm	1200 mm	2510 mm	\$432.00	N/A	N/A
LSWB27060 (-T,W,G,B)	2700 mm	600 mm	2810 mm	\$296.00	\$384.00	\$339.00
LSWB27080 (-T,W,G,B)	2700 mm	800 mm	2810 mm	\$346.00	\$437.00	N/A
LSWB270120 (-T,W,G,B)	2700 mm	1200 mm	2810 mm	\$466.00	N/A	N/A
LSWB30060 (-T,W,G,B)	3000 mm	600 mm	3110 mm	\$356.00	\$435.00	\$381.00
LSWB30080 (-T,W,G,B)	3000 mm	800 mm	3110 mm	\$418.00	\$493.00	N/A
LSWB300120 (-T,W,G,B)	3000 mm	1200 mm	3110 mm	\$594.00	N/A	N/A

LONGSPAN WORK BENCH ACCESSORIES

Code	Product Name	RRP (Inc GST)
LP-LS600	Louvred Panel	\$49.00
LS-WHEEL-B	Wheel with Brake	\$19.00
LS-WHEELNB	Wheel without Brake	\$18.00
LS-TSB1200	Timber Support Bar	\$9.00
LS-TSB800	Timber Support Bar	\$8.00
LS-LPIN	Beam Safety Pin	\$1.00
LSWS5060	Wire Shelf	\$20.00
LSWS5080	Wire Shelf	\$26.00
LSWS6060	Wire Shelf	\$22.00
LSWS6080	Wire Shelf	\$28.00
LSGS6060	Galvanised Shelf	\$16.00
LSGS5060	Galvanised Shelf	\$14.00
BIN-BG1	Plastic Bin - Blue	\$2.50
BIN-BG2	Plastic Bin - Red	\$3.00
BIN-BG3	Plastic Bin - Yellow	\$3.50
BIN-BG4	Plastic Bin - Blue	\$5.50
BIN-BG5	Plastic Bin - Red	\$6.00



NOTE: All prices are subject to change without prior notice

4 TIER LONGSPAN WORK BENCH

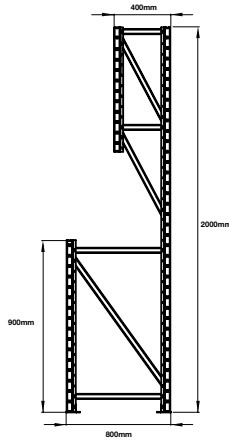

Code	Beam Length	Depth	Overall Length	RRP (Inc GST)
LSWBUS2006040-15	1500 mm	600 mm	1610 mm	\$370.00
LSWBUS2008040-15	1500 mm	800 mm	1610 mm	\$404.00
LSWBUS2006040-18	1800 mm	600 mm	1910 mm	\$402.00
LSWBUS2008040-18	1800 mm	800 mm	1910 mm	\$436.00
LSWBUS2006040-20	2000 mm	600 mm	2110 mm	\$442.00
LSWBUS2008040-20	2000 mm	800 mm	2110 mm	\$482.00
LSWBUS2006040-24	2400 mm	600 mm	2510 mm	\$486.00
LSWBUS2008040-27	2400 mm	800 mm	2510 mm	\$526.00
LSWBUS2006040-27	2700 mm	600 mm	2810 mm	\$534.00
LSWBUS2008040-24	2700 mm	800 mm	2810 mm	\$584.00
LSWBUS2006040-30	3000 mm	600 mm	3110 mm	\$640.00
LSWBUS2008040-30	3000 mm	800 mm	3110 mm	\$702.00

PALLET RACKING WORK BENCHES



PALLET RACKING WORK BENCH CONFIGURATION

Standard Work bench

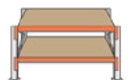

Code	Width	Depth	Shelf Material	RRP (Inc GST)
PRWB1829838-T	1829 mm	838 mm	25 mm MDF Board	\$694.00
PRWB18291219-T	1829 mm	1219 mm	25 mm MDF Board	\$728.00
PRWB2591838-T	2591 mm	800 mm	25 mm MDF Board	\$762.00
PRWB25911219-T	2591 mm	1200 mm	25 mm MDF Board	\$796.00

NOTE: All prices are subject to change without prior notice