

WORK BENCHES



**LONGSPAN
WORK BENCHES**



**4 TIER
LONGSPAN
WORK BENCHES**



**PALLET RACKING
WORK BENCHES**



Undershelf Options



Timber

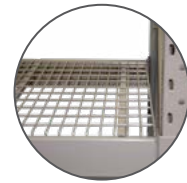

Wire

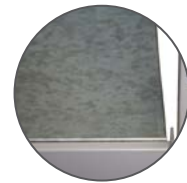

Galvanised

Wheels

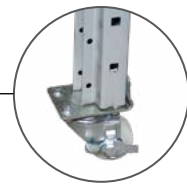

Wheels w/ Brake
Wheels w/o Brake

Longspan Work Bench Standard Finishes

- Powder-coated Grey
- Powder-coated White
- Powder-coated Black

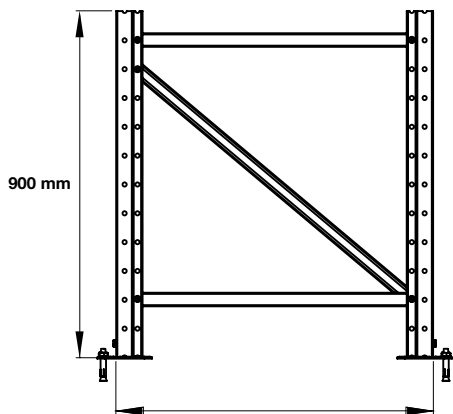

OPTIONAL WIDTHS 600, 800, 1200 mm

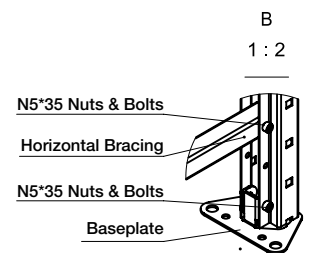
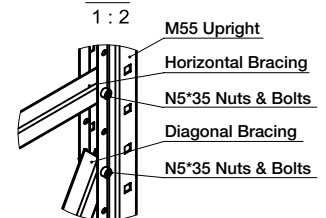
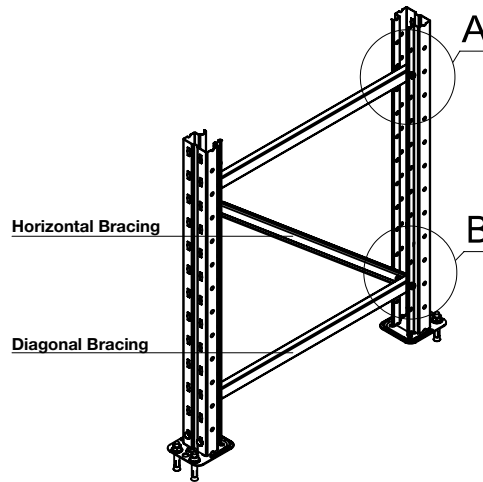

BEAM LENGTH 900, 1200, 1500, 1800, 2000, 2400, 3000 mm

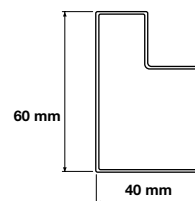
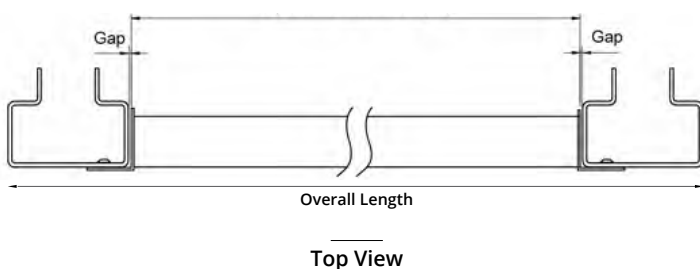

Step Beam
Cross Section



Step Beam
Side View

LONGSPAN WORK BENCH CONFIGURATION

Standard Work bench

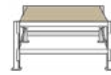

Timber Undershef

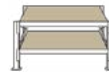

Wire Undershef

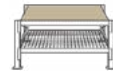

Galvanised Undershef



Code	Beam Length	Depth	Overall Length	RRP (Inc GST)	RRP (Inc GST)	RRP (Inc GST)	RRP (Inc GST)
LSWB9060 (-T,W,G,B)	900 mm	600 mm	1010 mm	\$172.00	\$182.00	N/A	N/A
LSWB9080 (-T,W,G,B)	900 mm	800 mm	1010 mm	\$181.00	\$196.00	N/A	N/A
LSWB90120 (-T,W,G,B)	900 mm	1200 mm	1010 mm	\$216.00	\$258.00	N/A	N/A
LSWB12060 (-T,W,G,B)	1200 mm	600 mm	1310 mm	\$191.00	\$204.00	\$247.00	\$235.00
LSWB12080 (-T,W,G,B)	1200 mm	800 mm	1310 mm	\$201.00	\$220.00	\$269.00	N/A
LSWB120120 (-T,W,G,B)	1200 mm	1200 mm	1310 mm	\$237.00	\$284.00	N/A	N/A
LSWB15060 (-T,W,G,B)	1500 mm	600 mm	1610 mm	\$212.00	\$230.00	\$287.00	\$272.00
LSWB15080 (-T,W,G,B)	1500 mm	800 mm	1610 mm	\$225.00	\$252.00	\$315.00	N/A
LSWB150120 (-T,W,G,B)	1500 mm	1200 mm	1610 mm	\$274.00	\$342.00	N/A	N/A
LSWB18060 (-T,W,G,B)	1800 mm	600 mm	1910 mm	\$229.00	\$248.00	\$313.00	\$295.00
LSWB18080 (-T,W,G,B)	1800 mm	800 mm	1910 mm	\$243.00	\$272.00	\$345.00	N/A
LSWB180120 (-T,W,G,B)	1800 mm	1200 mm	1910 mm	\$293.00	\$364.00	N/A	N/A
LSWB20060 (-T,W,G,B)	2000 mm	600 mm	2110 mm	\$246.00	\$270.00	\$346.00	\$326.00
LSWB20080 (-T,W,G,B)	2000 mm	800 mm	2110 mm	\$262.00	\$298.00	\$382.00	N/A
LSWB200120 (-T,W,G,B)	2000 mm	1200 mm	2110 mm	\$326.00	\$418.00	N/A	N/A
LSWB24060 (-T,W,G,B)	2400 mm	600 mm	2510 mm	\$271.00	\$296.00	\$383.00	\$359.00
LSWB24080 (-T,W,G,B)	2400 mm	800 mm	2510 mm	\$288.00	\$326.00	\$424.00	N/A
LSWB240120 (-T,W,G,B)	2400 mm	1200 mm	2510 mm	\$352.00	\$446.00	N/A	N/A
LSWB30060 (-T,W,G,B)	3000 mm	600 mm	3110 mm	\$317.00	\$352.00	\$467.00	\$437.00
LSWB30080 (-T,W,G,B)	3000 mm	800 mm	3110 mm	\$342.00	\$398.00	\$522.00	N/A
LSWB300120 (-T,W,G,B)	3000 mm	1200 mm	3110 mm	\$417.00	\$540.00	N/A	N/A

LONGSPAN WORK BENCH ACCESSORIES

Code	Product Name	RRP (Inc GST)
LP-LS600	Louved Panel	\$49.00
LS-Wheel-B	Wheel with Brake	\$21.00
LS-WheelNB	Wheel without Brake	\$18.50
LSWS5060	Wire Shelf	\$25.00
LSWS5080	Wire Shelf	\$30.00
LSWS6060	Wire Shelf	\$28.00
LSWS6080	Wire Shelf	\$34.00
LSGS6060	Galvanised Shelf	\$22.00
LSGS5060	Galvanised Shelf	\$20.00
TSB1200	Timber Support Bar	\$11.00
TSB800	Timber Support Bar	\$9.00
BIN-BG1	Plastic Bin - Blue	\$2.50
BIN-BG2	Plastic Bin - Red	\$3.00
BIN-BG3	Plastic Bin - Yellow	\$3.50
BIN-BG4	Plastic Bin - Blue	\$5.50
BIN-BG5	Plastic Bin - Red	\$6.00
SP	Beam Safety Pin	\$1.00



NOTE: All prices are subject to change without prior notice

4 TIER LONGSPAN WORK BENCH

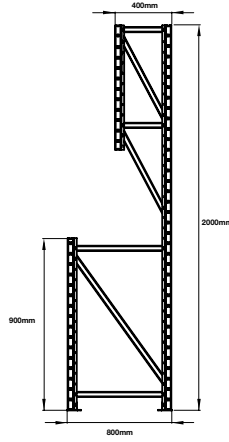

Code	Beam Length	Depth	Overall Length	RRP (Inc GST)
LSWBUS2006040-15	1500 mm	600 mm	1610 mm	\$430.00
LSWBUS2008040-15	1500 mm	800 mm	1610 mm	\$459.00
LSWBUS2006040-18	1800 mm	600 mm	1910 mm	\$465.00
LSWBUS2008040-18	1800 mm	800 mm	1910 mm	\$495.00
LSWBUS2006040-20	2000 mm	600 mm	2110 mm	\$500.00
LSWBUS2008040-20	2000 mm	800 mm	2110 mm	\$532.00
LSWBUS2006040-24	2400 mm	600 mm	2510 mm	\$551.00
LSWBUS2008040-24	2400 mm	800 mm	2510 mm	\$584.00
LSWBUS2006040-30	3000 mm	600 mm	3110 mm	\$645.00
LSWBUS2008040-30	3000 mm	800 mm	3110 mm	\$686.00

PALLET RACKING WORK BENCHES



PALLET RACKING WORK BENCH CONFIGURATION

Standard Work bench

Timber Undershef

Wire Undershef

Galvanised Undershef

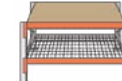
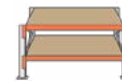
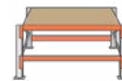

Code	Width	Depth	Shelf Material	RRP (Inc GST)
PRWB1829838-T	1829 mm	838 mm	25 mm MDF Board	\$419.00
PRWB18291219-T	1829 mm	1219 mm	25 mm MDF Board	\$445.00
PRWB2591838-T	2591 mm	800 mm	25 mm MDF Board	\$503.00
PRWB25911219-T	2591 mm	1200 mm	25 mm MDF Board	\$529.00

NOTE: All prices are subject to change without prior notice